

Drop-In Drop-in refrigerated well, static (1 GN container capacity)

ITEM # _____

MODEL # _____

NAME # _____

SIS # _____

AIA # _____



341156 (D10C1)

Drop-in Refrigerated Well,
static (1 GN container
capacity)

Main Features

- CB and CE certified by a third party notified body.
- Designed to be positioned in flush installation providing improved cleanability and suitable for modern design installations.
- Designed to serve the food in gastronorm containers.
- Suitable for GN 1/1 containers with a maximum height of 200 mm.
- Precise temperature control and setting at 0,1°C .
- As standard the product comes with digitally controlled thermostat which is in line of HACCP norms and provides visual alarm as a warning of the increasing or decreasing temperatures.
- Available drop-in dimensions: 1, 2, 3, 4, 5, 6 GN.
- Food introduced at the correct temperature maintains its core temperature according to Afnor Standards.
- Automatic defrosting guarantees evaporators clearance and efficient well cooling.
- Remote version is available.

Construction

- Electronic control with temperature display.
- Well bottom is inclined to facilitate water drainage.
- Well in 304 AISI stainless steel with rounded corners to facilitate cleaning operations. The well is also equipped with a drain hole.
- IPx2 water protection.
- The bottom is equipped with copper tubes to ensure proper cooling, with this system the air touches the cold surface and gets cooled.

Sustainability



- High-density expanded polyurethane foam with cyclopentane guarantees excellent well insulation to reduce energy dispersion.
- Hydrocarbon refrigerant gas R290 for the lowest environmental impact (GWP=3) - CFC and HCFC free.

APPROVAL: _____

Rear side

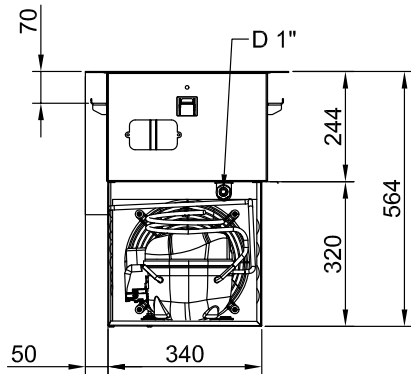

Side

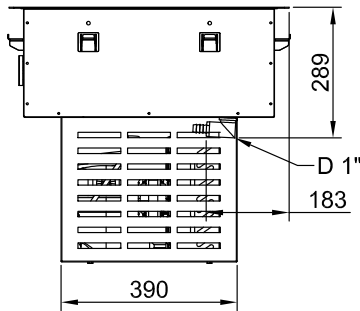

D = Drain
 EI = Electrical inlet (power)

Top

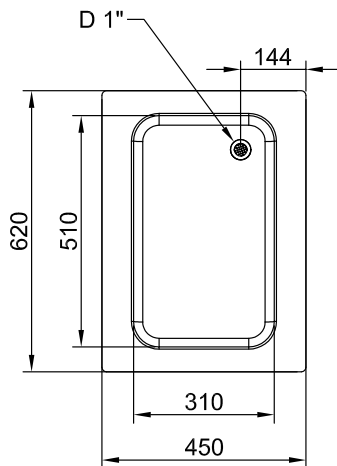

Electric

Supply voltage:

341156 (D10C1) 220-240 V/1N ph/50 Hz

Electrical power max.:

0.47 kW

Water:

Water drain outlet size:

1"

Key Information:

External dimensions, Width: 450 mm

External dimensions, Depth: 620 mm

External dimensions, Height: 595 mm

Net weight: 41.5 kg

Shipping weight: 51 kg

Shipping height: 720 mm

Shipping width: 490 mm

Shipping depth: 660 mm

Shipping volume: 0.23 m³

Set temperature: -15 / 0 °C

Refrigeration Data

Refrigerant type:

R290

Sustainability

Noise level:

62 dBA

Drop-In
Drop-in refrigerated well, static (1 GN container capacity)

The company reserves the right to make modifications to the products without prior notice. All information correct at time of printing.

2024.09.04

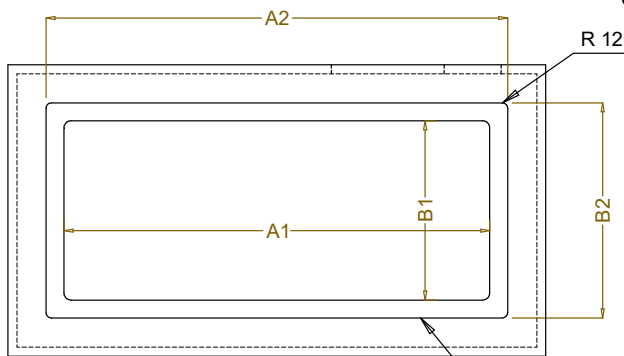

CAPACITY	CUTOUT		LOWERING FOR FLUSH INSTALLATION		C	K
	A1	B1	A2	B2		
1GN	380	580	454	624	560	380
2GN	700		774			
3GN	1030		1104			
4GN	1350		1424			
5GN	1670		1744			
6GN	2000		2074			

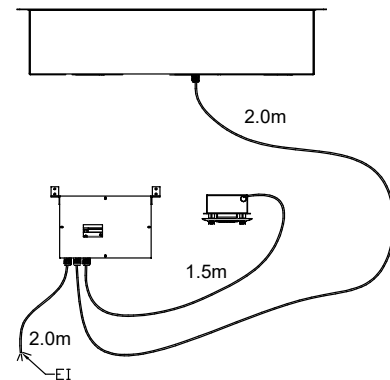
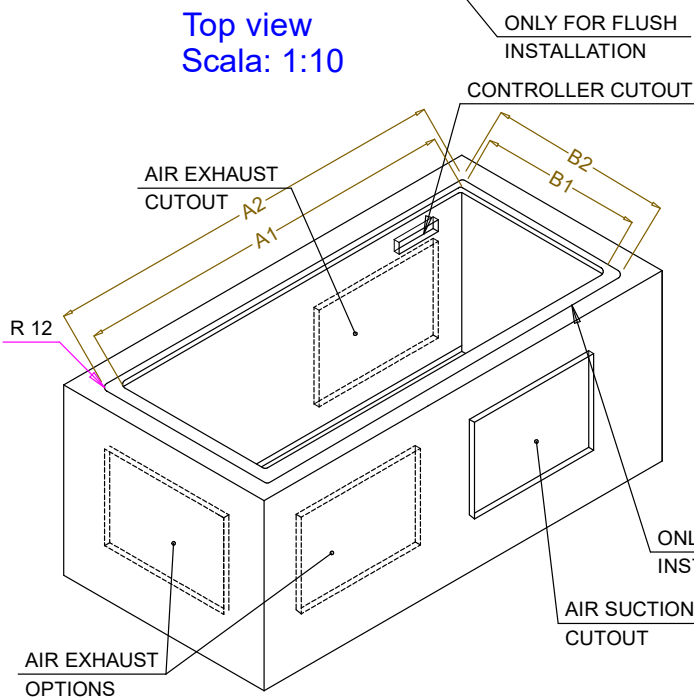

595T01S00 - COLD STATIC WELL